

LA-9288-MS

(ISPO-170)

2

Los Alamos National Laboratory is operated by the University of California for the United States Department of Energy under contract W-7405-ENG-36.

PROGRAM FOR
TECHNICAL ASSISTANCE
AND SAFEGUARDS

DO NOT CIRCULATE

PERMANENT RETENTION

REQUIRED BY CONTRACT

LOS ALAMOS NATIONAL LABORATORY



3 9338 00308 5411

*Active Coincidence Collar for Total
Plutonium Measurement of MOX Fuel Assemblies*

Los Alamos Los Alamos National Laboratory
Los Alamos, New Mexico 87545

This work was supported by the US Department of Energy, Office of Safeguards and Security, and by the Program for Technical Assistance to IAEA Safeguards.

Edited by Sarah Kreiner, Group Q-1

DISCLAIMER

This report was prepared as an account of work sponsored by an Agency of the United States Government. Neither the United States nor the United States Department of Energy, nor any of their employees, makes any warranty, express or implied, or assumes any legal liability or responsibility for the accuracy, completeness, or usefulness of any information, apparatus, product, or process disclosed, or represents that its use would not infringe privately owned rights. Further, neither the subject matter nor the content of this report reflects any policy, expressed or implied, by the United States Government.

LA-9288-MS
(ISPO-170)

UC-15
Issued: May 1982

Passive/Active Coincidence Collar for Total Plutonium Measurement of MOX Fuel Assemblies

H. O. Menlove

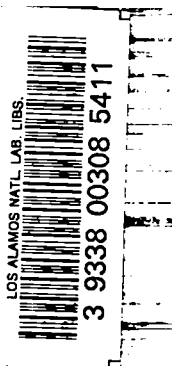

Los Alamos Los Alamos National Laboratory
Los Alamos, New Mexico 87545

CONTENTS

ABSTRACT	1
I. INTRODUCTION	2
A. PASSIVE MODE	2
B. ACTIVE MODE	3
II. EQUIPMENT DESCRIPTION	3
III. HELIUM-3 NEUTRON DETECTORS	5
IV. PERFORMANCE CHARACTERISTICS: PASSIVE MODE	8
V. PASSIVE/ACTIVE MODE	10
APPENDIX A: CADMIUM ABSORBER STUDIES	14
APPENDIX B: ERROR STUDIES	16
REFERENCES	19

PASSIVE/ACTIVE COINCIDENCE COLLAR FOR TOTAL PLUTONIUM
MEASUREMENT OF MOX FUEL ASSEMBLIES

by

H. O. Menlove

ABSTRACT

A passive coincidence collar has been developed for the passive/active assay of fuel assemblies containing plutonium. In the passive mode, the neutrons originating from spontaneous fission reactions are measured using normal neutron coincidence counting to determine the ^{240}Pu -effective mass. In the active mode, the passive neutrons are reflected back into the assembly to induce fission reactions in the fissile component of the fuel. To determine the neutron fraction resulting from the reflection process, the albedo of the boundary surrounding the assembly is changed by inserting or removing a cadmium liner.

The efficiency and die-away time of the coincidence collar have been modified by placing cadmium and CH_2 sleeves around each ^3He detector tube. The resulting efficiencies can be varied from 5 to 17% and the die-away times from 10 to 55 μs . The optimum combination is selected to correspond to the plutonium mass to be measured. Measurement precisions (1σ) of 0.3% for the passive-mode measurement and 1.2% for the active-mode measurement (1000 s) are estimated from counting statistics for a light-water-reactor mixed-oxide (LWR-MOX) fuel assembly.

The passive/active coincidence technique can be used on fast-breeder-reactor (FBR) and LWR-MOX fuel assemblies, spent-fuel assemblies, and bulk samples of PuO_2 and UF_6 .

INTRODUCTION

Two types of neutron coincidence collars have been developed for non-destructive assay of fuel assemblies: (1) the standard Coincidence Collar,¹ designed for active assay of light-water-reactor (LWR) fuel assemblies that contain no plutonium, and (2) the Passive Coincidence Collar, designed for passive/active assay of fast-breeder-reactor (FBR) and LWR mixed-oxide (MOX) fuel assemblies, spent-fuel assemblies, and bulk samples of PuO₂ and UF₆.

For LWR fuel (UO₂), an AmLi interrogation source is used to induce fission reactions in the ²³⁵U contained in the fuel assembly; the coincidence rate is proportional to the fissile content. On the other hand, for LWR-MOX fuel (UO₂ and PuO₂), the plutonium in the fuel provides a passive neutron signal that can be used for the assay. The standard Coincidence Collar has been modified for FBR and LWR-MOX fuel assembly assay by replacing the AmLi neutron source with a fourth detector bank to give symmetry to the detection efficiency.

This report describes the modified unit, the Passive Coincidence Collar. This collar has been specifically designed for measurement of prototype fast-reactor (PFR) subassemblies that are contained in canisters for storage. The subassemblies are to be measured without removing them from the canisters; thus, a rather large detector opening (>20 cm) is required to accommodate the canisters.

A. Passive Mode

The passive coincidence count determines the ²⁴⁰Pu-effective defined² by

$$^{240}\text{Pu-effective} = 2.43 \text{ }^{238}\text{Pu} + 1.0 \text{ }^{240}\text{Pu} + 1.69 \text{ }^{242}\text{Pu} .$$

Additional information such as the plutonium isotopic ratios is needed to determine the total plutonium content. Another approach that can be used to obtain the total plutonium content is to combine the passive measurement with an active measurement of the fissile content in the assembly.

B. Active Mode

The large quantity of PuO_2 in a MOX fuel assembly is a strong source ($\sim 10^6$ n/s) of fast neutrons (1-2 MeV); these neutrons originate from spontaneous fission and (α, n) reactions. In addition, significant neutron multiplication results from induced fission reactions in the plutonium. These neutrons can be used for self-interrogation of the assembly by reflecting them back into the assembly with the CH_2 body of the collar. To distinguish between the fraction of neutrons caused by the primary neutron source and the fraction resulting from the reflection process, it is necessary to change the albedo, or the reflection property, of the boundary surrounding the assembly. By using the difference in the responses between the reflective and nonreflective boundaries, it is possible to isolate the portion of the signal caused by the induced fissions in the fuel from that caused by the reflected neutrons.

This general approach has been investigated previously by Krick and Close³ for FBR subassemblies and by Lee and Lindquist⁴ for pressurized-water-reactor (PWR) spent-fuel assemblies under water. The work reported here has an important difference in that coincidence counting is used rather than singles counting. This has the advantage of enhancing the induced fission fraction over the gross neutron background because the induced fissions have a higher effective neutron multiplicity. Coincidence counting also helps the response to penetrate into the center of the assembly; the multiplication is higher in the center and is amplified by coincidence counting. This phenomenon was also observed¹ with the standard Coincidence Collar.

II. EQUIPMENT DESCRIPTION

The Passive Coincidence Collar shown in Fig. 1 has been designed with the same dimensions and materials as the standard Coincidence Collar with the following exceptions.

- The side containing the AmLi source has been replaced by a fourth detector bank.

- The holes in the CH₂ slabs for the ³He tubes have been enlarged so that a 4-mm-thick CH₂ sleeve with a cadmium wrap can be inserted around each tube.
- The inside surfaces of the detector banks have cadmium liners to reduce neutron multiplication in the sample from reflected neutrons. These liners can be removed to enhance the reflected neutrons for active-mode fissile measurements.

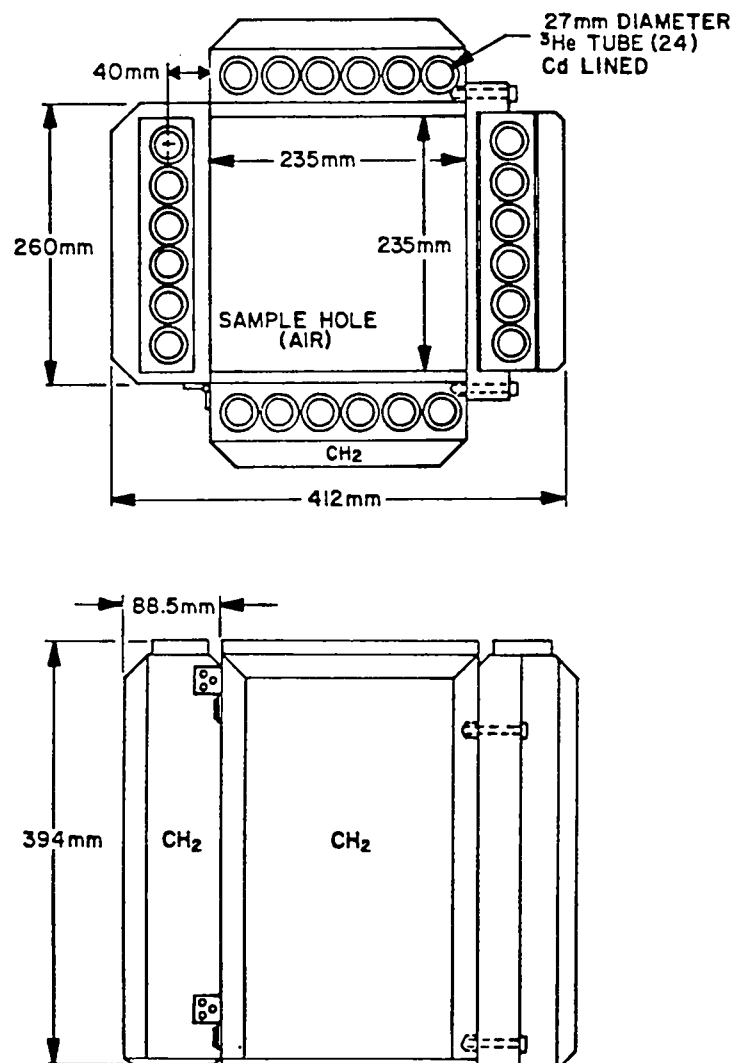

Fig. 1.
Schematic diagram of the Passive Coincidence Collar for applications to MOX fuel assemblies.

All of these modifications can be reversed so that parts used in the Passive Coincidence Collar can also be used in the International Atomic Energy Agency (IAEA) Class III Coincidence Collar.

Figure 2 is a photograph of the Passive Coincidence Collar detector head and Fig. 3 shows the complete unit, including the electronics and cart. The equipment supplied to the IAEA includes the following:

- four CH₂ detector slabs
- twenty-four CH₂ sleeves (4 mm thick) with 0.08- to 0.16-mm-thick cadmium wraps
- four ³He detector banks of six tubes each (24 tubes total)
- one IRT preamplifier box
- one set of high-voltage detector cables for the four detector banks
- one support cart for the collar and electronics.

Figure 4 shows the fourth CH₂ slab, the high-voltage and preamplifier box, and one of the CH₂ sleeves partially withdrawn from the slab. Figure 5 is a schematic diagram of one of the CH₂ sleeves that fit around each ³He tube. The thin cadmium wrap was selected to absorb part, but not all, of the low-energy neutrons. Details are given in Appendix A on cadmium absorber studies.

III. HELIUM-3 NEUTRON DETECTORS

The 24 ³He neutron detectors are matched in all properties to those contained in the present IAEA Coincidence Collars. As a result, the detector banks can be interchanged between the two types of units. Characteristics of the detectors are given in Table I.

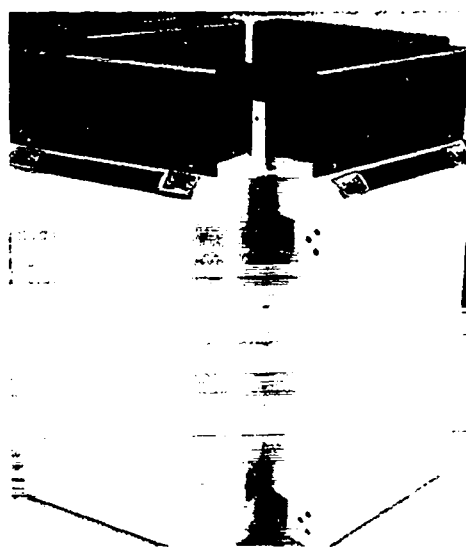

Fig. 2.
Photograph of the Passive Coincidence Collar detector head.

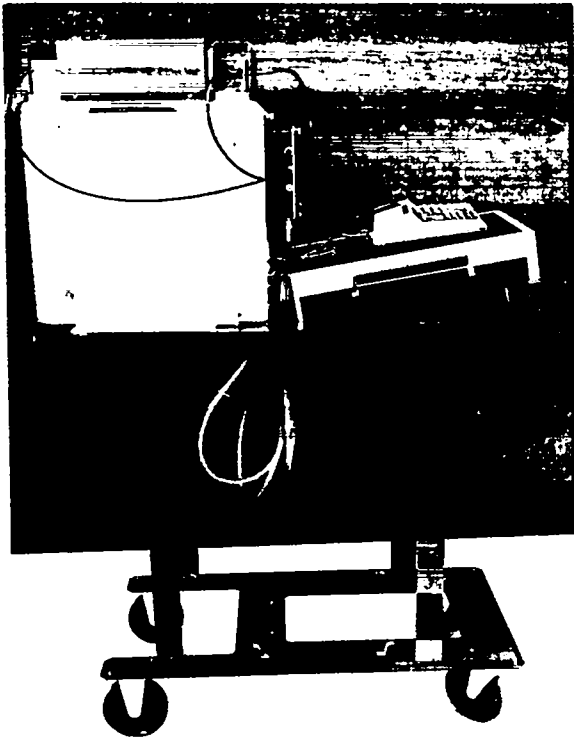

Fig. 3.

Photograph of the complete Passive Coincidence Collar, including detector head, IRT Model HEC-100 coincidence electronics, HP-97 calculator, and support cart.

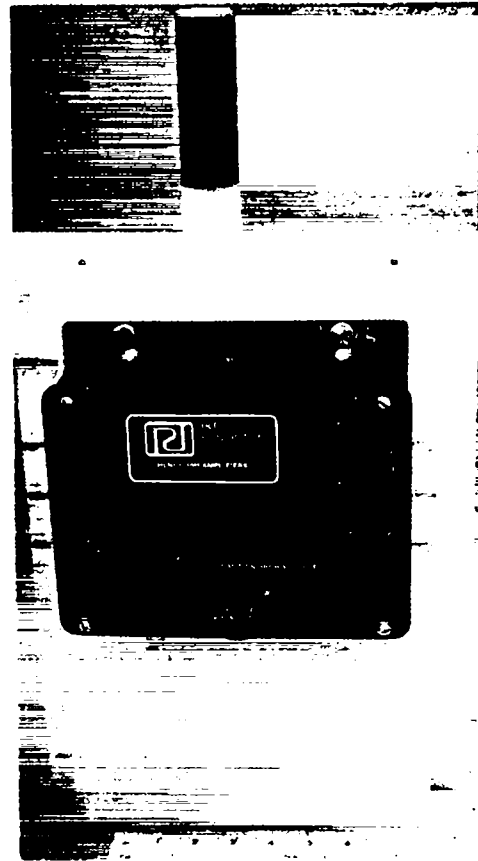

Fig. 4.

Detector support bank with one of the six CH_2 sleeves partially removed to show the cadmium wrap.

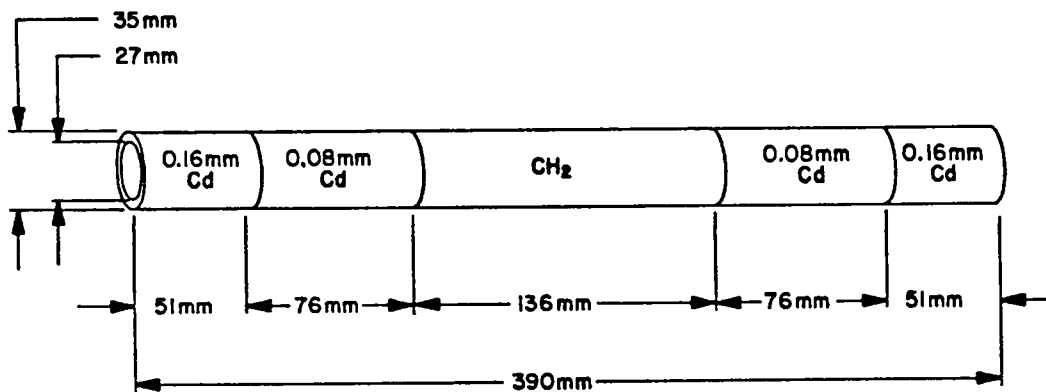

Fig. 5.

Schematic diagram of 4-mm-thick CH_2 sleeve and cadmium wrap.

TABLE I
NEUTRON DETECTOR CHARACTERISTICS

Reuter-Stokes	Model RS-P4-0813-101
Active length	33 cm
Diameter	2.54 cm
Cladding	aluminum
Pressure	4 atm
Operating hv	1500 V

After the tubes were connected into their junction box, desiccant was placed in the box and the lids were sealed with silicone rubber to prevent moisture buildup. The relative efficiency in each detector bank was measured using a ^{252}Cf neutron source. The results of the measurements are given in Table II. To obtain the close matching of the detector banks shown in Table II, two ^3He tubes were interchanged between the highest and lowest banks to bring them more into line. Because of the close matching of the detector banks and the symmetry of the system (see Fig. 1), it does not matter where the detector banks are placed in the CH_2 body.

TABLE II
DETECTOR BANK COMPARISON
PASSIVE COINCIDENCE COLLAR

<u>Detector Bank Number</u>	<u>Relative Efficiency</u>
1	1.000 ± 0.005
2	1.027 ± 0.005
3	1.000 ± 0.005
4	0.990 ± 0.005

IV. PERFORMANCE CHARACTERISTICS: PASSIVE MODE

Because of the large amount of plutonium in PFR subassemblies (~ 13 kg), direct use of the Coincidence Collar modified with four detector sides gives a total count rate that is about a factor of 2 too high for the normal shift register electronics. Also, the neutron die-away time of the standard collar is too large ($55 \mu\text{s}$), resulting in a large accidental pileup rate.

The purpose of using CH_2 sleeves with cadmium wraps (Fig. 5) is to give better statistical precision by the following changes.

- The efficiency is reduced by a factor of ~ 1.7 (because of count rate limitations).
- The die-away time is reduced from $55 \mu\text{s}$ to $28 \mu\text{s}$.
- The effective plutonium mass in the detector counting region is reduced by a factor of ~ 1.3 by the cadmium covers around the ends of the tube sleeves.

Placing the cadmium wrap on both ends of the CH_2 detector sleeve and leaving the central region open as shown in Fig. 5 has the additional advantage that the ends of the PFR fuel subassembly do not contribute as much to the count rate as they would without the cadmium. This reduces the effective plutonium mass in the active region of the detector and permits a higher efficiency to be used while still staying within the count rate limitations. Details concerning this advantage are given in Appendix B.

One measure of the profile collimation is the full width at half maximum (FWHM) of the detector system. To measure this parameter, a ^{252}Cf point source was moved along the axis of a mock-up fuel assembly, which was centered in the Passive Coincidence Collar. Figure 6 shows the totals and coincidence count rates normalized to unity in the midplane of the detector. The measured FWHM of 33 cm (12.9 in.) is 1.3 times smaller than that of the uncollimated detector. As can be seen from the coincidence curve in Fig. 6, the center of the detector should be placed at least 25 cm (10 in.) away from the ends of the plutonium fuel in the subassembly to avoid a count rate reduction from geometric end losses.

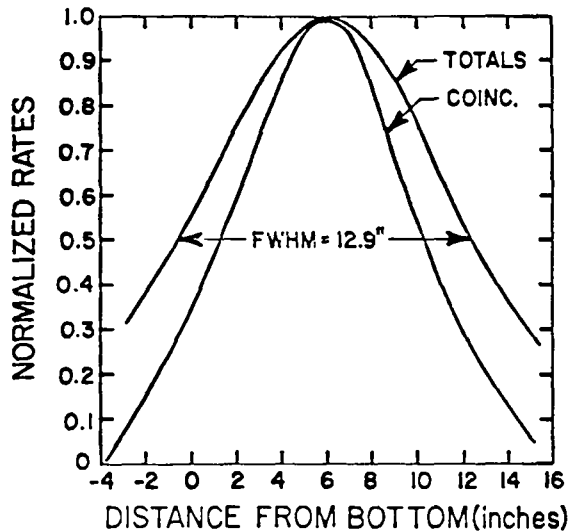

Fig. 6.
Passive Coincidence Collar response functions vs axial position in fuel assembly.

assay of a set of similar fuel assemblies, this is not a significant problem because the bias is roughly the same for all of the subassemblies and it cancels out in the calibration curve.

The characteristics of the Passive Coincidence Collar and the standard Coincidence Collar are given in Table III. The maximum totals rate is limited by deadtime considerations to $\sim 150\,000$ counts/s. The deadtime correction for the coincidence rate is calculated from the expression $e^{-\delta T}$, where $\delta = 3.0\ \mu\text{s}$ and T is the totals rate per second. For the case of $T = 150\,000$ counts/s, $e^{-\delta T}$ is 1.57. If the efficiency of the standard Coincidence Collar is not reduced, the error in the deadtime corrections can be larger than the statistical uncertainties. However, for the relative as-

TABLE III
COMPARISON OF THE COINCIDENCE COLLARS

<u>Parameter</u>	<u>Standard Coincidence Collar</u>	<u>Passive Coincidence Collar</u>
^3He detector size and high-voltage junction box	same	same
Number of detector banks	3	4
Neutron efficiency	17% (4 banks)	10% (4 banks)
Die-away time	55 μs	28 μs
Effective fuel length (FWHM)	41 cm	33 cm
Totals rate estimate for PFR fuel assembly	270 000 (too high)	128 000
Precision (200 s, 1σ)	NA	1.0%

An estimate of the statistical error for the Passive Coincidence Collar is plotted as a function of count time for a PFR subassembly in Fig. 7. A 200-s count should give a standard deviation of $\sim 1.0\%$. A typical measurement procedure would be to make three or four recycle runs of 100 s each to check the consistency of the data.

V. PASSIVE/ACTIVE MODE

The active-mode assay is based on the principle of self-interrogation by reflected passive neutrons. The neutrons originate from (α, n) reactions on the oxygen and possible contaminants, spontaneous fission from the even isotopes of plutonium ($^{238}\text{Pu} + ^{240}\text{Pu} + ^{242}\text{Pu}$), and multiplication neutrons resulting primarily from fissile material in the assembly. Figure 8 illustrates the fuel assembly surrounded by the Passive Coincidence Collar with the reflected neutrons returning from the walls of the collar. The return of thermal neutrons into the assembly can be prevented by insertion of a 0.4-mm-thick cadmium sheet between the wall and the assembly as shown in Fig. 8 by the dotted line. This effectively reduces the multiplication or reactivity of the assembly-moderator combination.

Both the coincidence rate R and the totals rate T are measured with and without the cadmium sheet. The normal passive-mode calibration curve corresponds to R vs ^{240}Pu -effective; it is generally necessary to make corrections

Fig. 7.
Estimate of the counting precision (standard deviation) vs time for a PFR subassembly inside the Passive Coincidence Collar.

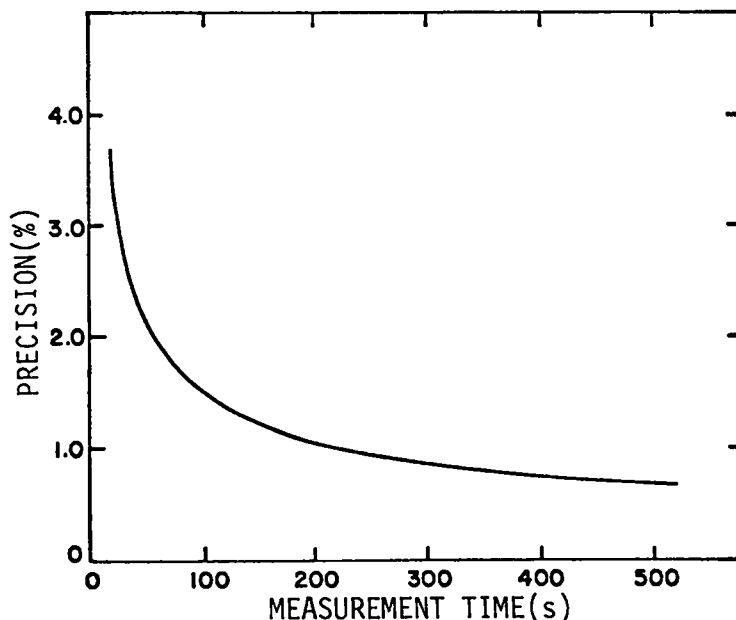

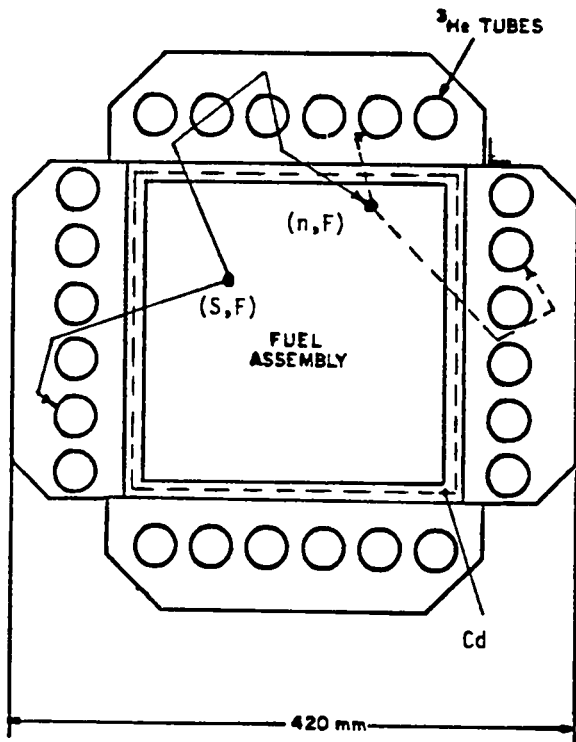

Fig. 8.
Schematic diagram of the neutron reflection method for a MOX fuel assembly inside the Passive Coincidence Collar.

To test this concept, a series of measurements were performed using a mockup PWR fuel assembly with removable rods. The characteristics of the fuel assembly are given in Table IV.

TABLE IV

MOCKUP PWR FUEL ROD CHARACTERISTICS

Array size	15 by 15
Number of rods	204 (21 open channels)
Rod diameter (o.d.)	10.8 mm
Rod cladding	Zircaloy-2
Uranium enrichment	3.19%
Linear ^{235}U loading (assembly)	38.76 g $^{235}\text{U}/\text{cm}$
UO_2 active length	1.035 m
UO_2 density	10.48 g/cm ³

for the multiplication from the fissile component. Various techniques have been used to make this correction, but the present cadmium ratio determination gives a more direct measure of the fissile component and multiplication than have past procedures.⁵

The induced fission rate from the reflected neutrons is related to

$$R(\text{no Cd}) - R(\text{Cd}) \equiv \Delta R .$$

However, the value of the induced coincidence counts is also proportional to the neutron source strength, which is different for each subassembly. To normalize the source strength out of the response function, divide by T to obtain the response ratio $\Delta R/T$, which is proportional to the fissile content independent of the source strength through a calibration curve.

For the experiments, a ^{252}Cf neutron source (2.3×10^4 n/s) was placed in the center of the 15 by 15 rod PWR mockup assembly. It is necessary to introduce the californium neutron source to simulate the PuO_2 source because the UO_2 has such a low intrinsic neutron yield. The assembly contained 204 fuel rods and had 21 control pin channels. Fuel rods were systematically removed from the assembly to change the uranium content by a maximum of 42 rods (Table V). Both T and R were measured for each rod loading configuration with and without the cadmium liner. The results of the response ratio $\Delta R/T$ vs uranium content are shown in Fig. 9. Replacing the ^{252}Cf source by one that was five times more intense did not change the value of the ratio $\Delta R/T$, showing the effectiveness of the source flux normalization procedure.

The fissions from the reflected neutrons are dominated by thermal-neutron fission reactions and normally this results in the problem of shallow penetrability of the interrogation. However, for high-mass samples such as LWR or FBR fuel assemblies, there is sufficient multiplication to propagate surface fission reactions into the interior of the sample. The neutron coincidence counting is important because it amplifies the multiplication response. For example, a normal spontaneous fission event has a ν (average number of neutrons per fission) of about 2.2, whereas the induced fissions from reflected spontaneous fission neutrons have an effective ν of ~ 3.6 ($2.2 - 1 + 2.4$) for the coincidence time gate (32-64 μs). The coincidence count rate is much more sensitive to the average value of ν than the totals rate.

TABLE V
RESULTS OF PASSIVE/ACTIVE MEASUREMENTS USING
PWR MOCKUP FUEL ASSEMBLY

Number of Rods Removed	Totals/s T(Cd)	T(no Cd) - T(Cd) (ΔT)	R(no Cd) - (R Cd) (ΔR)	$\frac{\Delta R}{T(\text{Cd})} \times 100$
0	3104	658	161.5	5.20
12	3060	628	149.2	4.88
22	3019	587	135.6	4.49
32	2950	563	117.0	3.99
42	2915	531	109.6	3.76

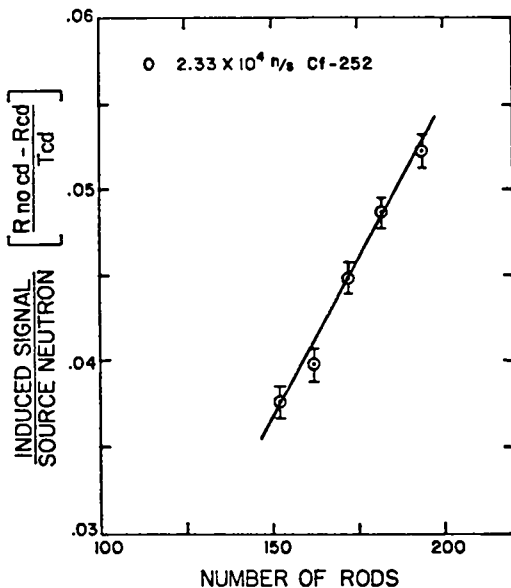

Fig. 9.
Measured coincidence response per source neutron $[R(\text{noCd}) - R(\text{Cd})]/T(\text{Cd})$ vs fissile content in the PWR mockup assembly using a ^{252}Cf driver source.

To check the penetrability of the technique, 10 rods were removed from the perimeter and $\Delta R/T$ was measured. These rods were then replaced and 10 rods were removed from the central section of the assembly. The values of $\Delta R/T$ were the same within a statistical precision of a few per cent. An estimate of the statistical error in using this technique is given in Appendix B.

In summary, the method gives the reactivity of the fuel assembly, which is primarily a function of the fissile content for a given sample-moderator configuration such as a fuel assembly. For FBR subassemblies, the combination of the active fissile determination with the passive-mode $^{238}\text{Pu} + ^{240}\text{Pu} + ^{242}\text{Pu}$ measurement gives a more complete verification of the total plutonium content.

This general technique can be applied to any high-mass sample of PuO_2 and UF_6 , as well as MOX fuel assemblies and spent-fuel assemblies. The primary requirements are that the sample has a self-source of neutrons, a well-defined geometry, and a reasonably large geometric cross section or solid angle to enable the reflected neutrons to hit the sample. Test and evaluation of the passive/active technique will be performed in the future for different types of FBR and LWR-MOX fuel assemblies. The technique has particular promise for FBR fuel assemblies because the total plutonium content can be verified both before and after irradiation in the reactor.

APPENDIX A

CADMIUM ABSORBER STUDIES

A series of measurements were performed to determine the optimum thickness of the cadmium wrap and of the CH_2 sleeve between the cadmium wrap and the ^3He tube. For thick cadmium wrap (≥ 0.4 mm), the efficiency increases linearly with CH_2 sleeve thickness up to ~ 1 -2 cm. The die-away time also increases with CH_2 thickness.

Figure A-1 shows a calculated graph⁶ of the die-away time and relative efficiency as a function of the thickness of the CH_2 sleeve. The Monte Carlo calculations were for a sleeve of CH_2 around a single ^3He tube. In the Passive Coincidence Collar, we position the ^3He tube and the CH_2 sleeve and cadmium wrap inside the larger CH_2 slab of the collar. This increases the efficiency by more than a factor of 3 without significantly increasing the die-away time.

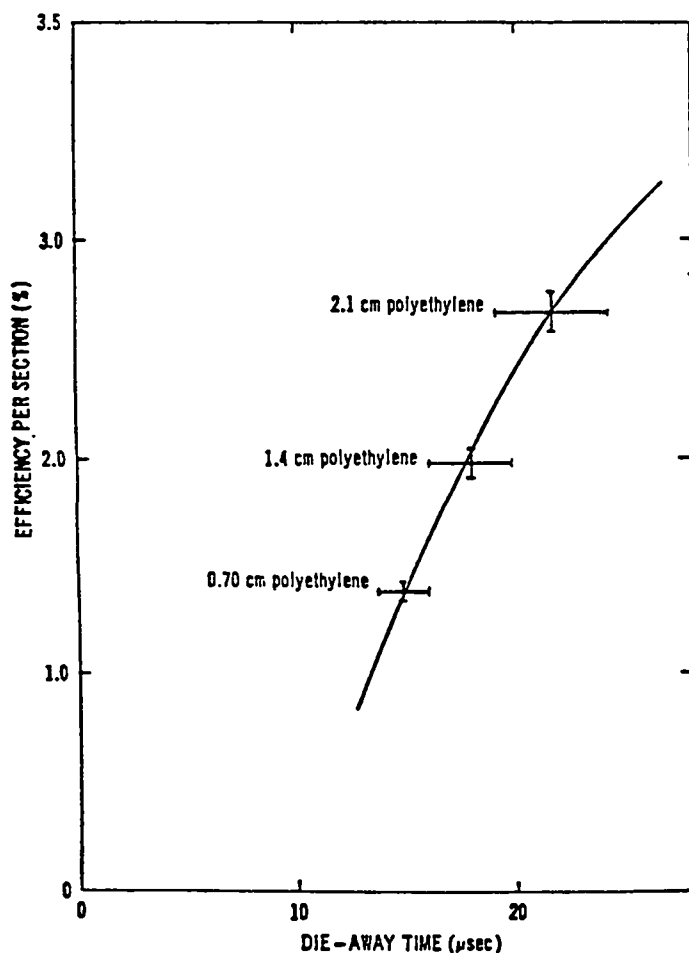

Fig. A-1.
Calculated graph from Evans⁶ of the die-away time and relative efficiency as a function of CH_2 sleeve thickness.

Table A-1 gives the results of the experiments concerned with the thickness of the cadmium wrap and CH₂ sleeve. We see that the efficiency (ϵ) and die-away time (τ) can be controlled by the thicknesses of the cadmium wrap and CH₂ sleeve. In general, the thicker the CH₂, the greater the efficiency and die-away time. Figure A-2 shows the measured efficiencies and die-away times for a full-length cadmium wrap (0.4 mm) around the CH₂ sleeve.

TABLE A-1
EXPERIMENTAL RESULTS FOR DIFFERENT
CADMIUM WRAP AND CH₂ SLEEVE THICKNESSES

Cadmium Wrap Thickness (mm)	CH ₂ Sleeve Thickness (mm)	Totals ^a T(s ⁻¹)	Reals ^a R(s ⁻¹)	Die-away Time (μs)
0	104 (All CH ₂)	7030	174	57
0.08	0	1670	8.5	37
0.08	3.0	1720	9.2	21
0.08	5.5	1995	13.7	16
0.16	5.5	1587	7.4	12
0.40	0 ^b	448	0.03	<4
0.40	3.0	893	1.0	8
0.40	5.5	1360	4.5	9
0.40	11.5	1934	23	14

^aAll the values correspond to a fixed ²⁵²Cf source position and a 32-μs gate.

^bA CH₂ sleeve of zero thickness corresponds to the cadmium being placed directly around the ³He tube.

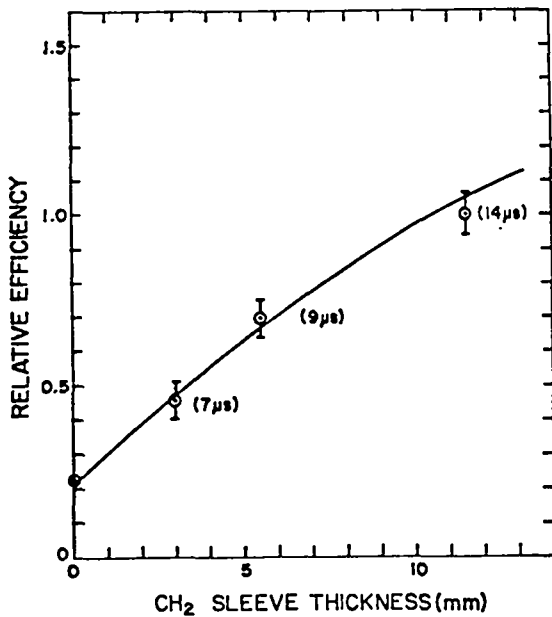

Fig. A-2.
Measured die-away time and relative detection efficiency (totals) as a function of CH₂ sleeve thickness with a cadmium (0.4 mm) wrap covering the entire outside surface of the CH₂ sleeve.

APPENDIX B
ERROR STUDIES

The per cent error in the coincidence counting can be expressed as

$$\sigma (\%) = \frac{\sqrt{(R + A) + A}}{R} \times 100\% ,$$

where R is the net real rate and A is the accidental rate. For high-mass PuO₂ samples, A >> R, and the error simplifies to

$$\sigma (\%) \sim \frac{\sqrt{2A}}{R} \times 100\% ,$$

but $A = T^2 G(\text{gate})$ and $G = 1.2\tau$, for minimum error.² Thus by combining the above equations, we can write

$$\sigma (\%) \sim \frac{\sqrt{2T^2(1.2t)}}{R} \times 100\% ;$$

however,

$$R \propto \epsilon^2 \text{ (counting efficiency)}$$

$$T \propto \epsilon .$$

Combining the terms gives the result that the fractional error is

$$\sigma \propto \frac{\sqrt{T}}{\epsilon} .$$

In summary, the statistical error is proportional to the square root of the die-away time and the inverse of the counting efficiency. So for minimum error, we desire a short die-away time and large efficiency. However, for samples with high count rates the efficiency is limited, to keep the total rate below $\sim 150\,000$ counts/s because of electronic deadtime considerations.

Thus, the optimum detector design for FBR subassemblies has an efficiency that gives a total rate of $\sim 150\,000$ counts/s for the subassembly that has the highest plutonium content and a low die-away time. This can be best achieved with a thin cadmium wrap around a ~ 12 mm-thick CH_2 sleeve. In this case we would have the maximum efficiency permitted and a τ of ~ 15 μs .

The CH_2 slabs and the ^3He tube spacing in the Passive Coincidence Collar limit the thickness of the CH_2 sleeves to only 4 mm. This results in a good τ (~ 11 μs), but the efficiency is too low. To raise the efficiency, the central 136-mm section of the ^3He tube and CH_2 sleeve has no cadmium wrap (see Fig. 5). This increased τ to ~ 28 μs , and thus the optimum gate setting is $\sim 1.2\tau$, or 32 μs . These parameters give the expected statistical performance shown in Fig. 7.

The statistical error for a LWR-MOX fuel assembly using the passive/active method can be estimated from the mockup fuel assembly measurements. The key parameters in the error consideration are the coincidence rate and the signal/background ratio, where ΔR is the signal and $R(\text{Cd})$ is the effective background. The induced signal ΔR has to be a reasonable fraction ($>10\%$) of the coincidence rate R to obtain accurate assays. For the PWR mockup assembly, $\Delta R/R(\text{Cd})$ was 42%.

An estimate of the standard deviation for the passive mode is given by

$$\sigma_{\text{passive}} (\%) = \frac{\sqrt{R + 2A}}{\sqrt{t} R} \times 100\% \quad , \quad (\text{B-1})$$

where t is the measurement time in seconds and A is the accidental rate.²

For the active mode, both the reflected and unreflected rates combine in the error estimate, giving

$$\sigma_{\text{active}} (\%) = \frac{\sqrt{(R + 2A)n_{\text{Cd}} + (R + 2A)\text{Cd}}}{\sqrt{t} \Delta R} \times 100\% \quad . \quad (\text{B-2})$$

For a MOX subassembly, the per cent statistical error can be estimated using the above equations and typical plutonium loading values. For example, for a 17 x 17 rod assembly containing 2% plutonium enrichment, the plutonium loading per unit length is about 30 g Pu/cm. Thus, there would be roughly 1 kg of plutonium in the 33-cm active region of the collar. The neutron yield from this amount of plutonium (20% ²⁴⁰Pu) is approximately 3.8×10^5 n/s, which includes some primary neutron multiplication.

The efficiency of the Passive Coincidence Collar can be tailored from 5 to 17% by changing the configuration of the CH₂ sleeves and cadmium wraps around the tubes. For the present case, it is best to use the collar in its normal configuration with the full 17% efficiency. The rates are then

$$T_{(\text{Cd})} = 3.8 \times 10^5 \times 0.17 = 64,600 \text{ s}^{-1} \quad ,$$

$$R_{(\text{Cd})} = 7580 \text{ s}^{-1} \quad ,$$

$$A_{(\text{Cd})} = T^2 G = 267\,000 \text{ s}^{-1} \text{ for a } 64\text{-}\mu\text{s gate} \quad .$$

These values were obtained from extrapolation of coincidence measurements of FBR subassemblies.

Substituting these values into Eqs. (B-1) and (B-2) gives

$$\sigma_{(\text{passive})} = \frac{10.2\%}{\sqrt{t}} = 0.32\% \text{ for } t = 1000 \text{ s}$$

and

$$\sigma_{(\text{active})} = \frac{37.7\%}{\sqrt{t}} = 1.2\% \text{ for } t = 1000 \text{ s} ,$$

where the ratio of $R(\text{no Cd})/R(\text{Cd})$ was 1.42 from the measurements with the collar on the mockup assembly. It is clear from Eq. (B-2) that, if the reflected signal ΔR is reduced by one-half, the error is doubled. Thus a good geometric coupling is required between the assay sample and the reflecting boundaries.

The totals rate can also be used for the measurements with much better statistical accuracy; however, the signal/background ratio $\Delta T/T$ is 21%, a factor of 2 lower than $\Delta R/R$ (42%), and the penetration to the interior of the assembly is not as good. Because the systematic errors should dominate the statistical errors, it is probably better to use the totals rate only as a confirmation of the coincidence results.

REFERENCES

1. H. O. Menlove, "Description and Performance Characteristics for the Neutron Coincidence Collar for the Verification of Reactor Fuel Assemblies," Los Alamos National Laboratory Report LA-8939-MS, ISPO-142 (1981).
2. M. S. Krick and H. O. Menlove, "The High-Level Neutron Coincidence Counter (HLNCC): Users' Manual," Los Alamos Scientific Laboratory report LA-7779-M, ISPO-53 (June 1979).
3. J. L. Sapir, Comp., "Nuclear Safeguards Research Program Status Report, September-December 1976," Los Alamos Scientific Laboratory report LA-6788-PR (June 1977), D. A. Close and M. S. Krick, pp. 15-18.
4. G. R. Keepin, Ed., "Nuclear Safeguards Research and Development Program Status Report," Los Alamos Scientific Laboratory report LA-8373-PR (September 1980), D. M. Lee and L. O. Lindquist, p. 59.

5. M. S. Krick, "Neutron Multiplication Corrections for Passive Thermal Neutron Well Counters," Los Alamos Scientific Laboratory report LA-8460-MS (1980), pp. 59-62.
6. J. L. Sapir, Comp., Nuclear Safeguards Research Program Status Report, September-December 1976," Los Alamos Scientific Laboratory report LA-6788-PR (June 1977), M. L. Evans, H. O. Menlove, and L. G. Speir, pp. 8-10.

Printed in the United States of America
 Available from
 National Technical Information Service
 US Department of Commerce
 5285 Port Royal Road
 Springfield, VA 22161
 Microfiche \$3.50 (A01)

Page Range	Domestic Price	NTIS Price Code	Page Range	Domestic Price	NTIS Price Code	Page Range	Domestic Price	NTIS Price Code	Page Range	Domestic Price	NTIS Price Code
001-025	\$ 5.00	A02	151-175	\$11.00	A08	301-325	\$17.00	A14	451-475	\$23.00	A20
026-050	6.00	A03	176-200	12.00	A09	326-350	18.00	A15	476-500	24.00	A21
051-075	7.00	A04	201-225	13.00	A10	351-375	19.00	A16	501-525	25.00	A22
076-100	8.00	A05	226-250	14.00	A11	376-400	20.00	A17	526-550	26.00	A23
101-125	9.00	A06	251-275	15.00	A12	401-425	21.00	A18	551-575	27.00	A24
126-150	10.00	A07	276-300	16.00	A13	426-450	22.00	A19	576-600	28.00	A25
									601-up	†	A99

†Add \$1.00 for each additional 25-page increment or portion thereof from 601 pages up.

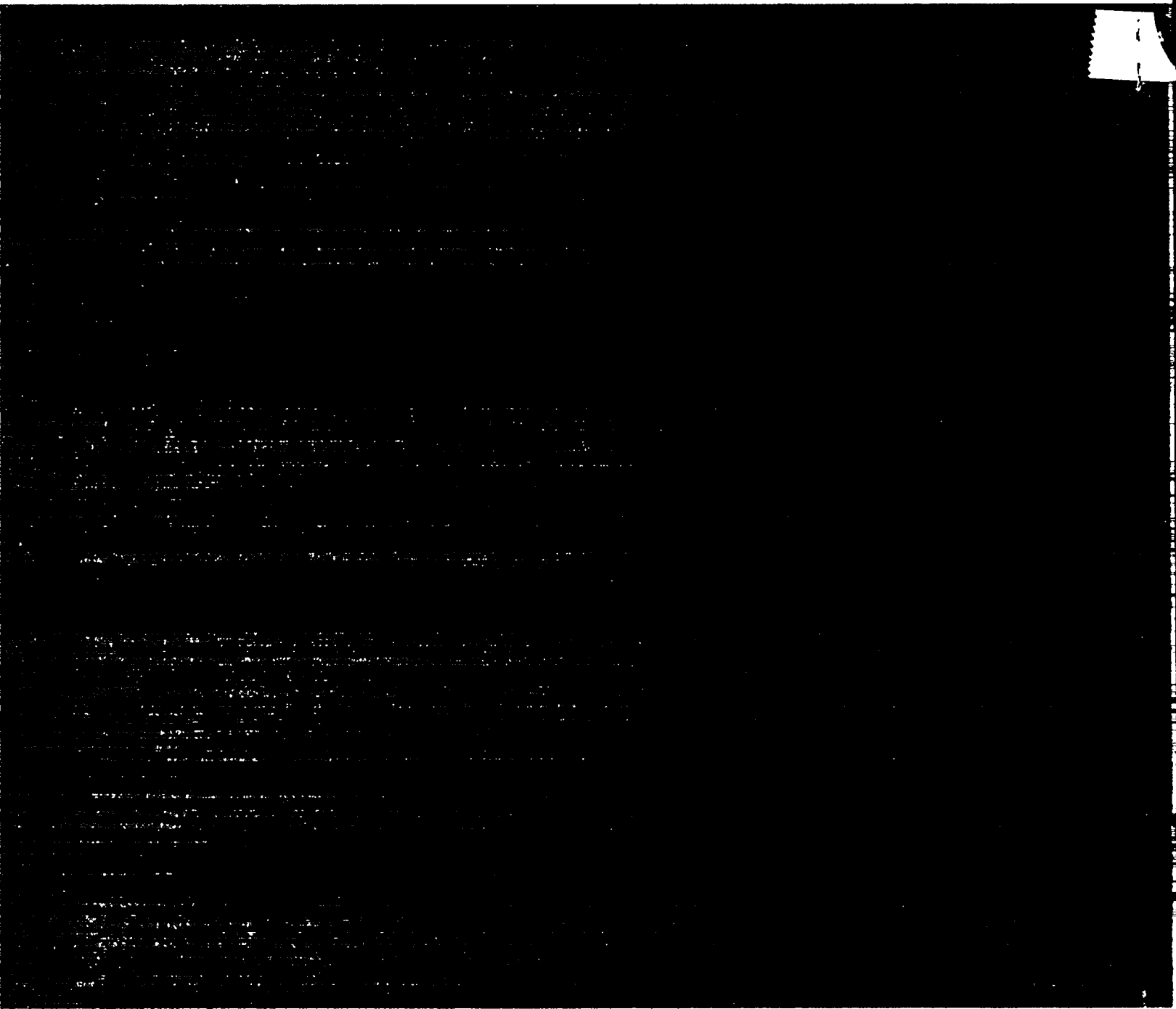

Los Alamos